

DreamVision EV5032 (8ch – 32/64ch) DVR

The Best DVR Solution

Pioneer Computers Australia



DreamVisionEV5008-32

Models

Model	fps@D1 per ch	Video Input	Audio Input	VGA Output	TV out (Main+Quad)	DVD Burner	Network	Alarm I/O
EV5008	15	8	8	1	1+4	1	Gigabit	8/8
EV5016	15	16	16	1	1+4	1	Gigabit	16/16
EV5024	15	24	24	1	2+8	1	Gigabit	16/16
EV5032	15	32	32	1	2+8	1	Gigabit	16/16

EV5024 & EV5032 to be available in 4Q, 2008



Front View I

Dimension: 427mm(W) x 491.2mm(D) x 177mm(H)



Front View II



Back View

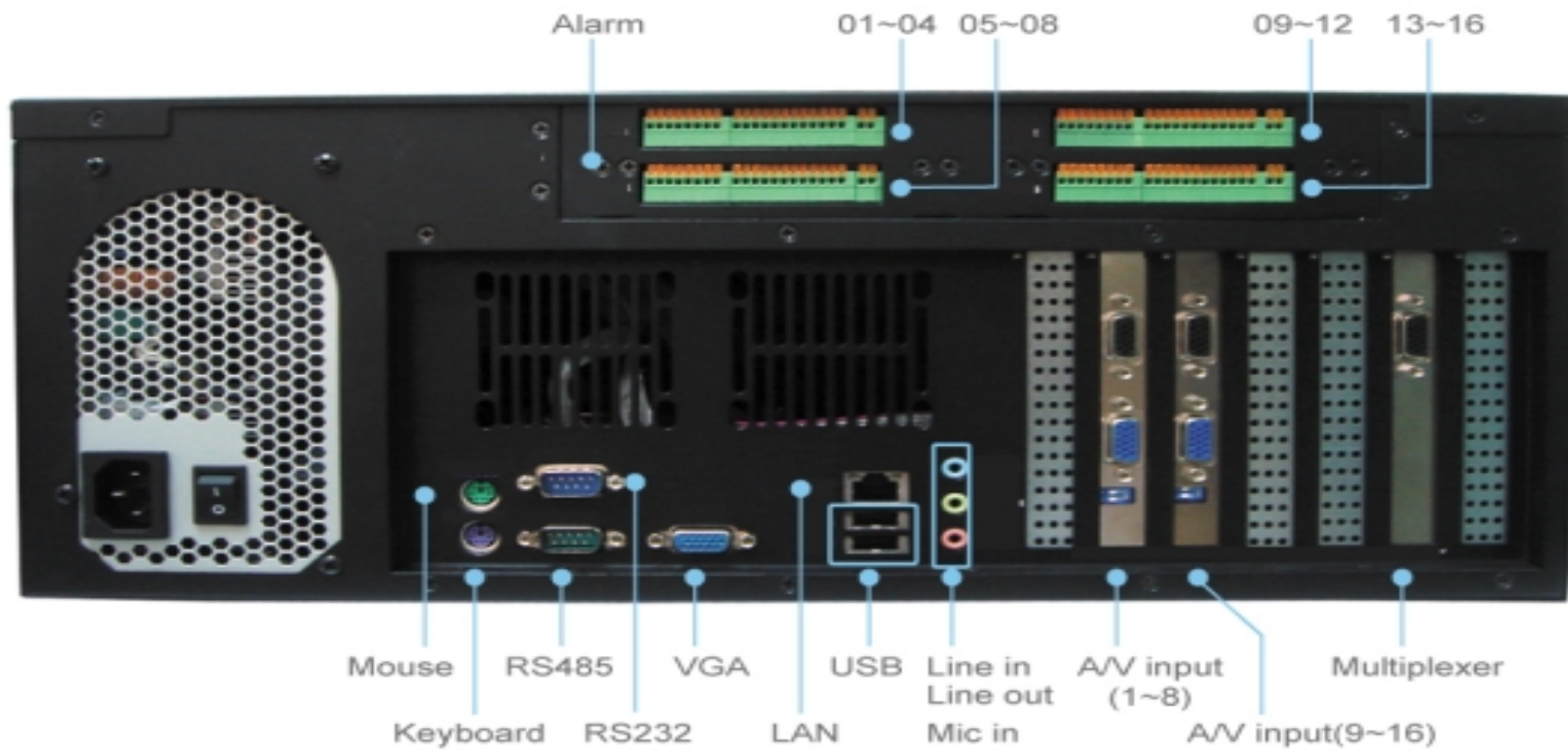



System Spec

Front	
RAID Box HDD Bay	5 slide in hot-swap SATA HDDs with RAID layer 0-5 function
DVD-RW	1*DVD-RW
USB	2*USB 2.0
LED Light	Power, Record, Alarm (DI/DO trigger), Error (Video Loss)
Rear	
Video Input	8, 16, 24, 32
TV Output (Main+Quad)	EV5008: 1+4, EV5016: 1+4, EV5024: 2+8, EV5032: 2+8
VGA Output	1*VGA output with 15 pin D-SUB connector
Audio Input	8, 16, 24, 32
Audio Output	1*Line out
Alarm Input	8, 16
Alarm Output	8, 16
PS/2	1*Keyboard, 1*Mouse
Ethernet	1*Gigabit Ethernet
COM Port	1*RS232 , 1*RS485



EV5032 S/W Features (I)

Rich Features Dwell in Reliable and Scalable Linux Platform

- Expandable from 8 to 32 channels residing in the same platform
- MPEG4 H/W DSP Compression Technology
- **Real-time Monitor and Recording @QVGA** for 8ch to 32ch Standard Model
- **Real-time Monitor and Recording @D1** for 8ch/16ch Premium Model
- Multi-tasking: Display, Recording, Playback, Remote and Backup
- Smart Motion Recording with recording frame rate automatically adjusted according to motion/event occurring
- Max. 16ch **Synchronized** Playback on DVR, remote IE and CMS
- Integrate with POS application
- Quick Playback Search by Date, Time, Event and Log
- Complete Alarm Notifications including Alarm to Zoom, Alarm to Recording, Pop Up Message, Alarm to DO Output and Alarm to Notice by Email/FTP and SMS
- Camera Mask Detection including Camera Covering and Spray Painting



EV5032 S/W Features (II)

Complete Data Storage Solution

- Build in RAID Box with 5 Hot Swappable SATA HDDs
- Support Max 1TB per HDD with Max 5TB HDD capacity in RAID 0
- Support RAID 0~5 with RAID Alarm Notification and RAID Configuration
- Build in One Internal DVD-RW
- Support Various Backup Device including Burning Devices and USB Storage Devices

Powerful Network Capability

- Support PPPoE, DDNS, DNS and DHCP
- Remote Monitor, Playback, Setup and Backup via PSTN and TCP/IP (LAN, WAN, Internet)
- Provide Powerful Central Management System and IE Client
- Support Remote Monitor Via 3G/GPRS/Wi-Fi Mobile Handsets
- Simultaneously 16 Remote Clients Monitoring



EV5032 S/W Features (III)

Full CCTV System Support

- 1 VGA Output
- TV out with Main Monitor and Multiple Quad Monitors
- Audio Inputs on All Video Channels
- Alarm Inputs on All Video Channels
- Four LED Light Indicators to show Crucial System Status including Power, Record, Alarm (DIDO trigger) and Error(Video Lose)

Hybrid IP Surveillance Capability (To be Available in 4Q, 2008)

- Support Both IP cameras and Analog Camera in One System
- Support up to 64ch (32ch analog+32ch IP cam) Hybrid DVR
- Support Panasonic, Axis, Vivotek, D-Link and A-MTK IP camera
- Support high-resolution over 1280*1024 and HD large screen TV



Selling Points for Projects

- A. Video Enhancement
- B. High Security Control
- C. Full Alarm Integration
- D. Complete Solution for Control Station
- E. Large Storage Supported
- F. Quick Search Tools
- G. Complete POS Integration
- H. Easy Remote Access
- I. Powerful Central Management System
- J. GPRS/3G/WiFi Supported
- K. RMSDK Supported



A. Video Enhancement

- Provide Four Color Adjustments
 - Brightness\Contrast\Saturation\Hue
- Provide Two Recording Modes to Meet Customer Requirement
 - Enhance Video Quality
 - Enhance Frame Rate
- Support Playback Video Enhancement Tools
 - De-interlace: Weave\Even Only
 - Sharpen
- Others
 - Motion/Alarm zoom-in
 - Full screen
 - Save and Print Snapshot



B. High Security Control

- Support 128 User Accounts
- Support Password Expiry Notification
- Monitor, Playback, Export, Setup and Remote Password Protection
- Real Time Event Detection
 - Motion Detection & Notification
 - Camera Mask Detection & Notification
 - Video Loss Detection & Notification
- Privacy Right Protection
 - User Defined HDD Recycle Duration from 1 to 365 days



C1. Alarm System Integration

- Alarm System Integration with
 - Intruder Detection System
 - Access Control
 - Fire alarm system
- Support Six Alarm Matrixes
 - Alarm Input to Camera Recording
 - Alarm Input to Alarm Output
 - Alarm to Zoom
 - Camera Motion to Alarm Output
 - Video Loss to Alarm Output
 - DVR System Event to Alarm Output
- All of the Alarm Outputs Can Trigger Alarm Notification by E-Mail/SMS/FTP

C2. Alarm Input Scenario

- Alarm System Integration with
 - Intruder Detection System
 - Access Control System
 - Fire Alarm System
 - Environment Detection System
- DVR Immediately React to Alarm Input

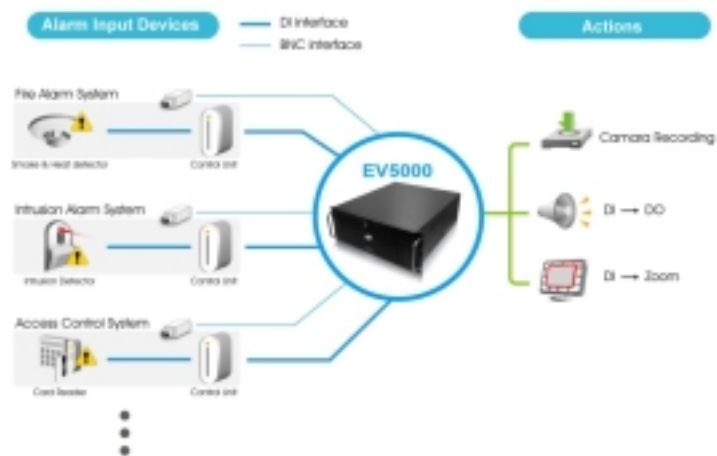

C3. Alarm Output Scenario

- All Alarm Outputs Can Trigger Alarm Notification by E-Mail/SMS/FTP

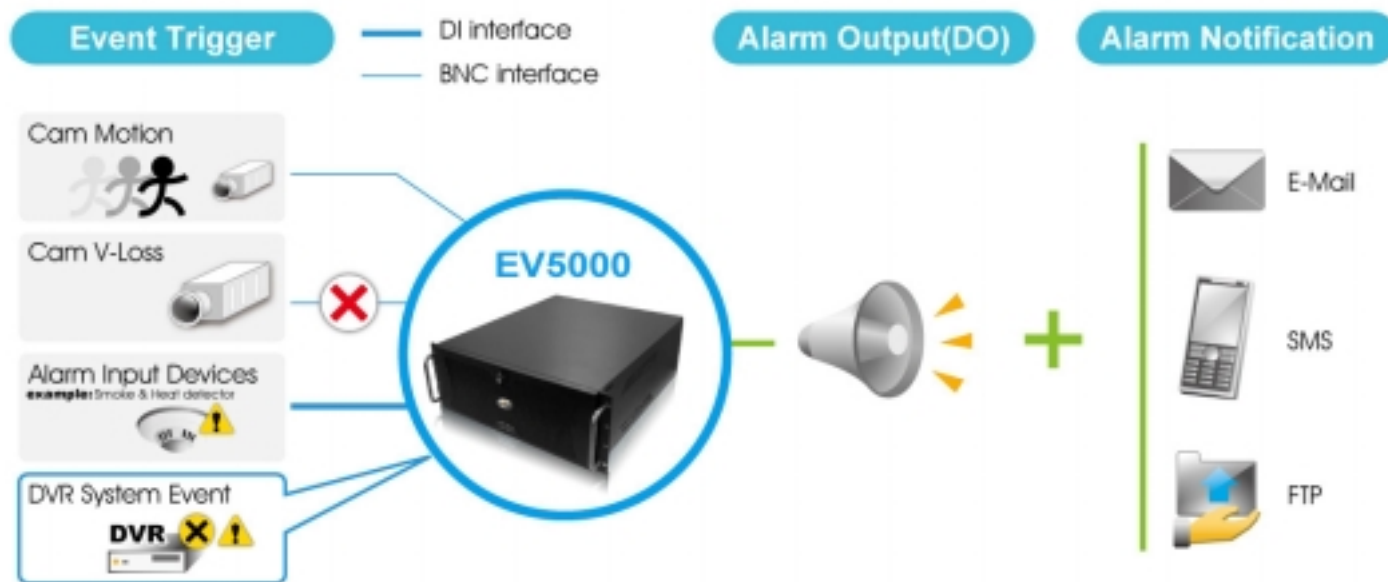

D. Complete Solution for Control Station

- 8ch to 32ch in One System
- Equipped with one VGA out
- Built-in Multiplexer with five TV-outs (1 - 2 Main monitor plus 4 - 8 Quad monitors)
- Four Alarm Indicators to show crucial system status including Alarm (DIDO trigger), Error (Video Loss), Recording and Power

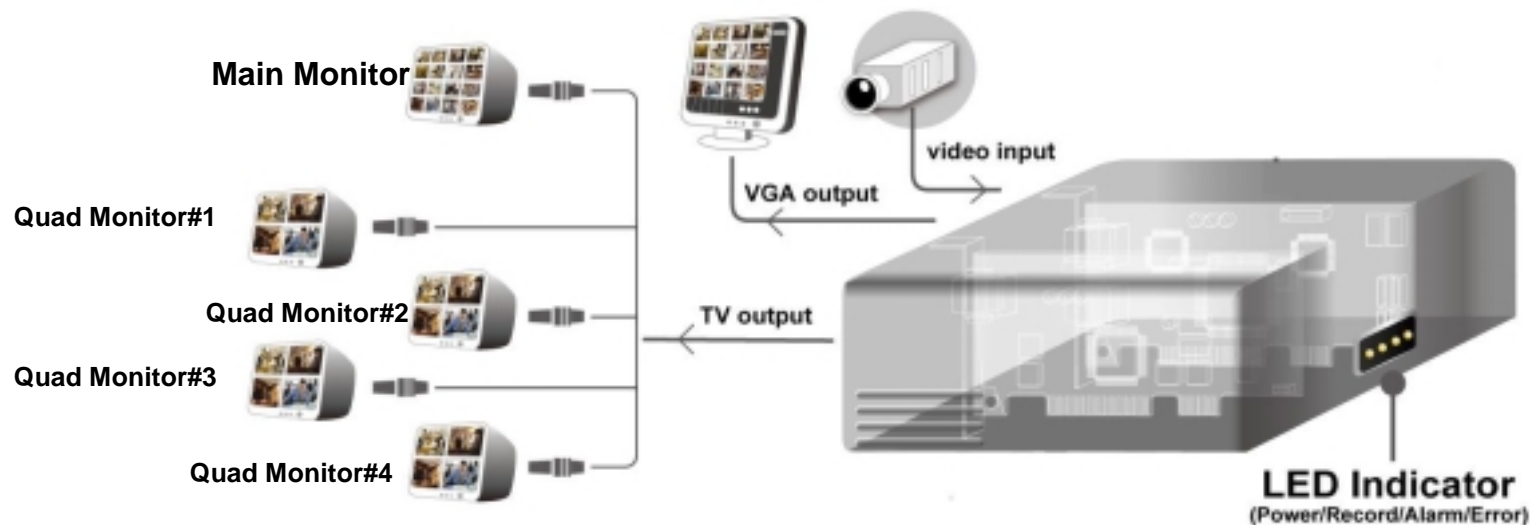



E. Large Storage Supported

- Build-in One RAID Box with RAID 0~5 Support
 - 5*SATA HDD Tray with Hot Swap Function
 - Support Max 5TB in One System
- RAID Box Integration
 - Support RAID configuration
 - Support RAID Event Notification
 - Fast data access
 - Complete file backup by data redundancy

F. Quick Search Tools

- Support Playback Search by
 - Calendar/Date/Time/Event/Log/POS
- Provide Efficient Search Tools to Narrow Down the Search Data

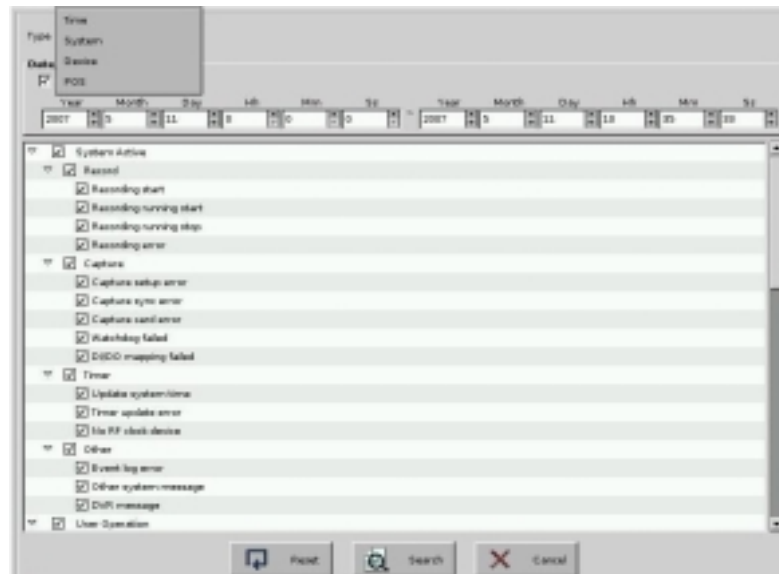

G1. POS Integration (I)

- Integrate with 3rd Party POS Systems
- Support Multiple POS Connections to One DVR System
- POS Event Search by
 - POS number
 - Camera number
 - Transaction amount
 - Product name/code
 - Credit number
 - Total transaction quantity
 - Sales clerk ID



Pioneer DreamVision



G2. POS Integration (II)

- POS Video Text Overlay
 - Display or hide transaction text messages on screen and on video files
 - Move and change Text Display location
 - Change Message Window Size
- Support Different Connection Interface
 - COM Port(RS232RS485)
 - Ethernet
 - USB

H. Easy Remote Access

4 Complete Remote Access & Management S/W Applications

- Web Viewer
- Remote Monitoring via GSM/GPRS/3G/Wi-Fi Mobile Handset or PDA
- Powerful Central Management System
- Remote Control Center (Optional)



H1. Web Viewer

- Web Viewer Supports
 - Max 16 clients access
 - 8 channel Synchronized playback
 - Snapshot & backup
 - Remote log query
 - Multiple monitor split modes
 - Multiplex language operation

Remote Monitor



Snapshot



Remote Log Query

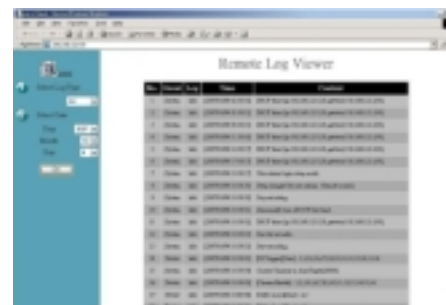

Remote Playback

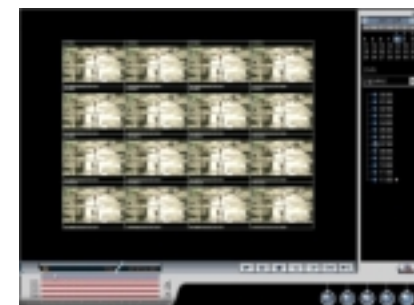

H2. Remote Monitoring via GSM/GPRS/3G/Wi-Fi Mobile Handset or PDA

- Remote Monitor
- Remote PTZ Control
- Snapshot
- Multiple Split Mode

Mobile Surveillance



I1. Powerful Central Management System

- Integrating Full Range of DVRs on the Main Screen
- Managing Max 64 DVRs with 1024 Chs
- Multiple Splits in Monitor
- Hierarchy E-MAP
- TV-Wall and Motion to Zoom
- Remote PTZ Control, Backup and Setup
- Event Log Query
- Online Playback and Download
- Alarm Pop-up
- Up to 200 DVRs Health Check
- Account Management Backup

Remote Monitor



Remote Playback



E-MAP



Snapshot

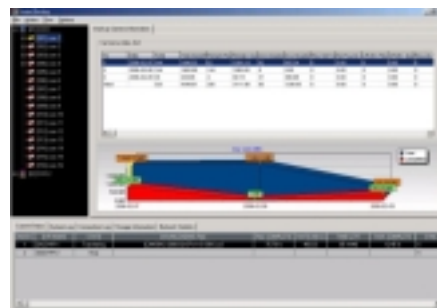



12. Remote Control Center I (Optional)

- To Monitor and Report DVR, Camera, HDD and Network Connection Status via PSTN and Ethernet.
- Tailor-made for ATM/Bank Networking and Central Operation
- Remote Health Check
 - Check & Report items:
 - Camera: Video Loss or No signal
 - HDD Status
 - Connection Status
 - Can set Query interval
 - Can click on each item to see detailed report
 - Summarized report including
 - Total camera number
 - Total error
 - Total warning



12. Remote Control Center II (Optional)

- Password Management
- Time Synchronization
- DVR Manager Module
- DVR management by Tree List
- Instant Playback, Monitor & Backup (Export)
 - Backup supports print function
 - Direct export file play without additional player
 - Password protection (ZIP plus password protection) on Export file

J. RMSDK Supported

- RMSDK(Remote Software Development Kit) can support customer to develop their own web viewer and CMS like applications or integration with 3rd party applications.

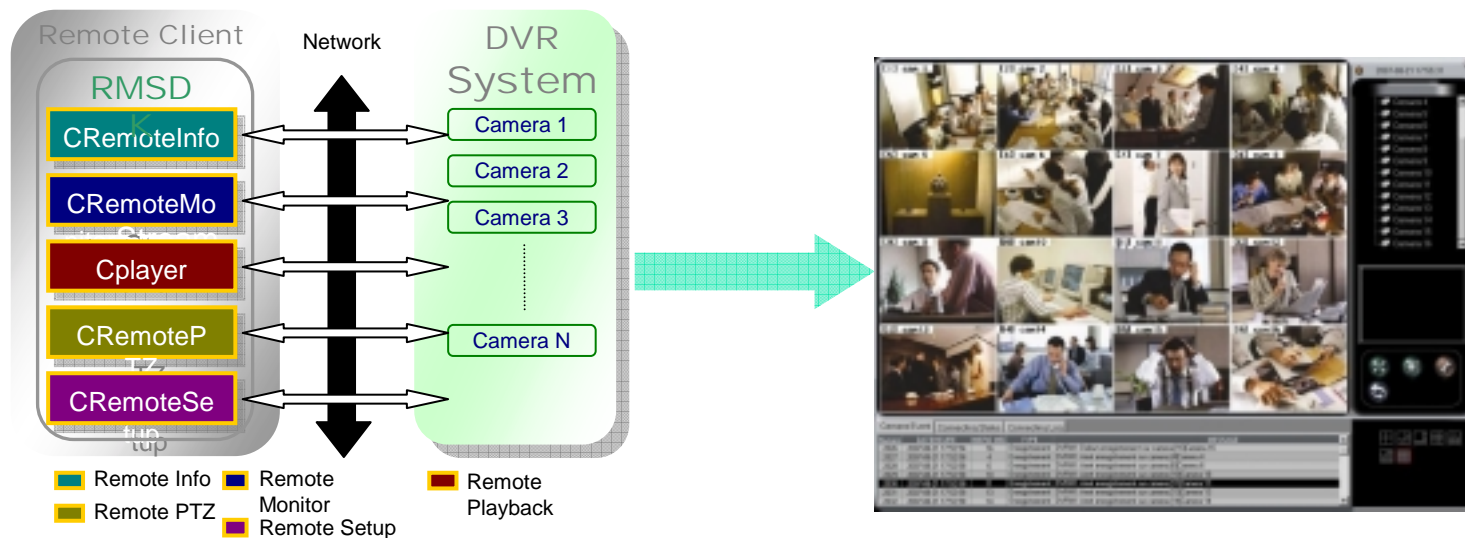



K1. EV5000 Your Best Solution for Projects (I)

- Best Solution for Banking

- Video Enhancement
- High Security Level
- Alarm System Integration
- Central Management
- Control Center
- Quick Search Tools
- Large Storage Supported..

- Best Solution for Retail

- Video Enhancement
- Quick Search Tools
- Alarm System Integration
- POS Integration..



K2. EV5000 Your Best Solution for Projects (II)

- Best Solution for Government
 - High Security Level
 - Alarm System Integration
 - Large Storage Supported
 - RMSDK Support

- Best Solution for Control Station
 - Video Enhancement
 - Alarm System Integration
 - Complete Solution for Control Station
 - Central Management
 - Quick Search Tools
 - Large Storage Supported..
 - Easy for Remote Access
 - RMSDK Support



S/W Specification (I)

System	
Video Input	8/16/24/32
Video Output	1*VGA, TV Out (Main Monitor + Quad Monitors)
Video Format	NTSC/PAL
Audio	
Input Channel	Audio inputs on all video channels
Output Channel	1 ch
Display	
Display Splits	4/6/8/9/13/16/
Sequencer	1/ 4
HDD Storage Display	Support
Display Password Protection	Support by channel



S/W Specification (II)

Recording	
Compression	MPEG4 DSP H/W Compression
Resolution	D1, QVGA
Frame Rate@QVGA	30fps/Ch(NTSC); 25fps/Ch(PAL)
Frame Rate@D1	15fps/Ch(NTSC); 12.5fps/Ch(PAL)
Recording Mode	Continuous/Non-recording/Motion/Event Recording
Pre-recording	0~10 sec
Post-recording	0~20 sec
Watermark	Support
Search & Playback	
Playback Channel	Max. 16 Ch Synchronized Playback
Playback Video Enhancement	De-Interlace, Sharpen
Search Mode	Search by Time, Date Event and Log



S/W Specification (III)

Alarm	
I&O Camera Relations	1-1, 1- many, many-1, many -many
Alarm Behavior	Complete Alarm Notifications including Alarm to Zoom, Alarm to Recording, Pop Up Message, Alarm to DO Output and Alarm to Notice by Email/FTP and SMS
Video Loss Detection	Support
Camera Mask Detection	Support
Motion to Zoom	Support
Storage & Backup	
RAID	Support RAID 0~5 with max 5TB capacity
	RAID event notification and RAID configuration
Backup	USB/IDE burning device(CD-RW, DVD+-RW); USB storage(Pen drive, HDD)
Disk Recycle Schedule	User self-defines HDD recycle schedule with range from 1 to 365 days
HDD Smart Diagnosis	Support



S/W Specification (IV)

Remote	
Networking	Internet/PSTN/LAN by Ethernet/Modem
3G/GPRS/Wi-Fi	Remote Monitoring
IE Browser	Max. 16 clients access simultaneously
	Max. 16 ch Synchronized playback
	Remote setup, remote playback and remote backup
Central Management System	Max. 64 DVR connections with 1024 chs
	Remote monitoring, remote playback, remote setup, remote backup
	Hierarchy E-MAP
Others	
PTZ Camera	Support
User Accounts	128 user accounts with password expiry notification
	Multiple levels user authority (Admin/Supervisor/User)
Time zone & Daylight Saving	Support
UI Language	English, Portuguese, Spanish, French, Japanese, Polish, Traditional Chinese and Simplified Chinese